

Overzicht maatvoering centraal beweegbaar (maten in mm)

Capital® aluminium lamelmaten:	A Uitvulling tot gevel	B Gevel tot hart lamel	C Gevel tot lamel open stand	D Gevel tot lamel, dichte stand dakpan	E Gevel tot lamel, dichte stand strak
150 Ellips	135	160	85	142	142
200 Ellips	135	160	60	139	140
250 Ellips	185	160	50	186	188
300 Ellips	185	210	60	184	187
150 Cubic	135	160	85	121	142
200 Cubic	135	160	60	121	142
250 Cubic	185	210	85	171	191
300 Cubic	185	210	60	161	187

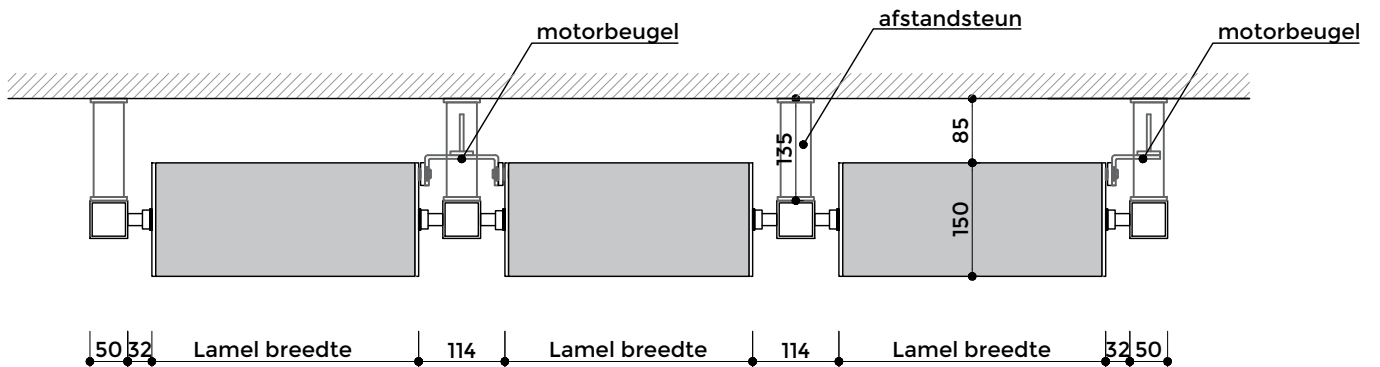

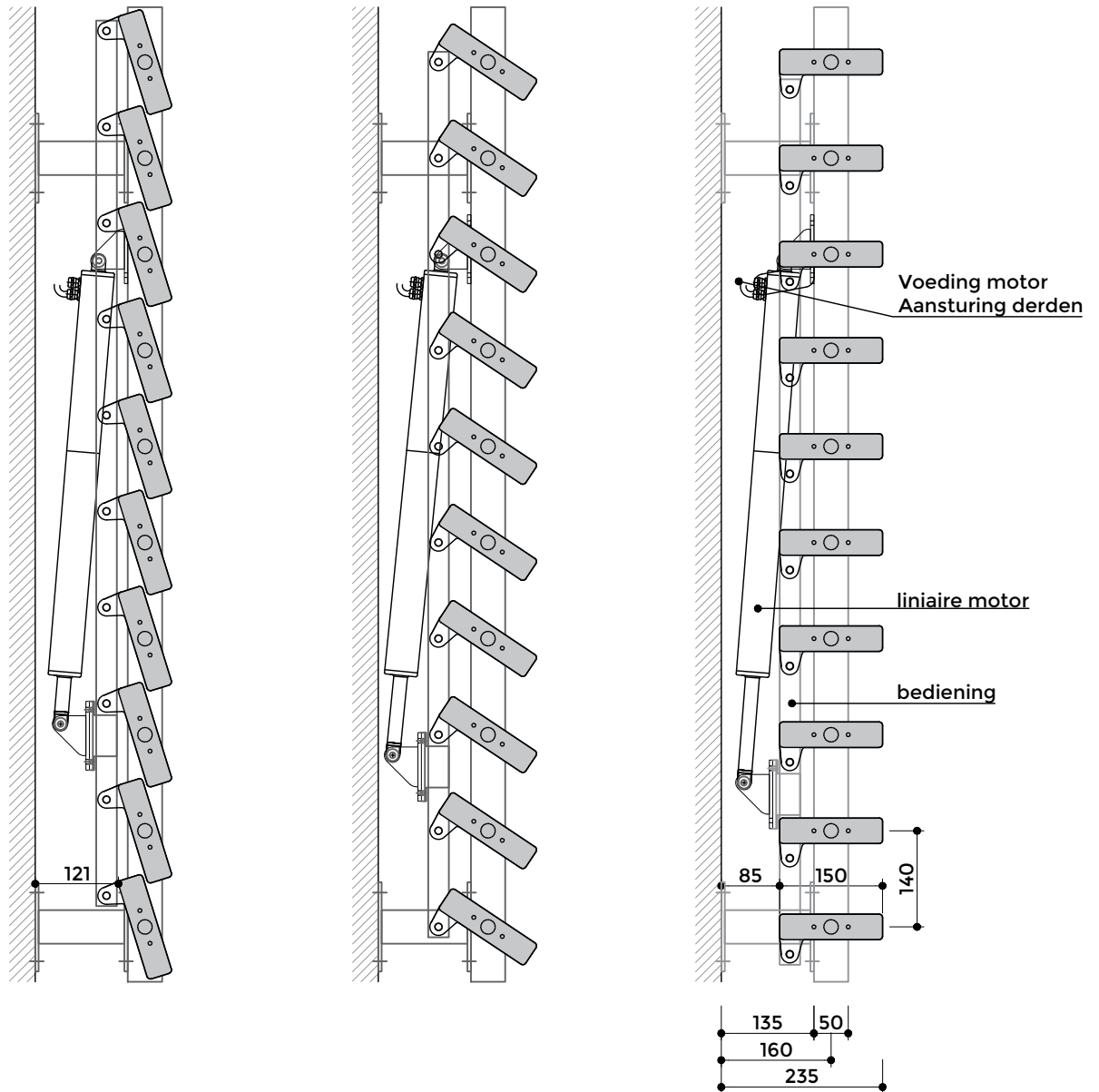

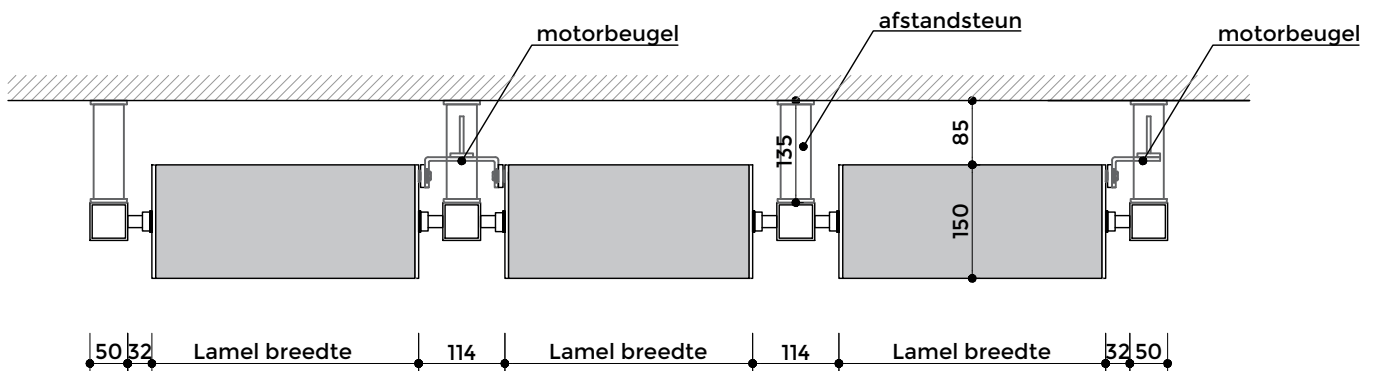
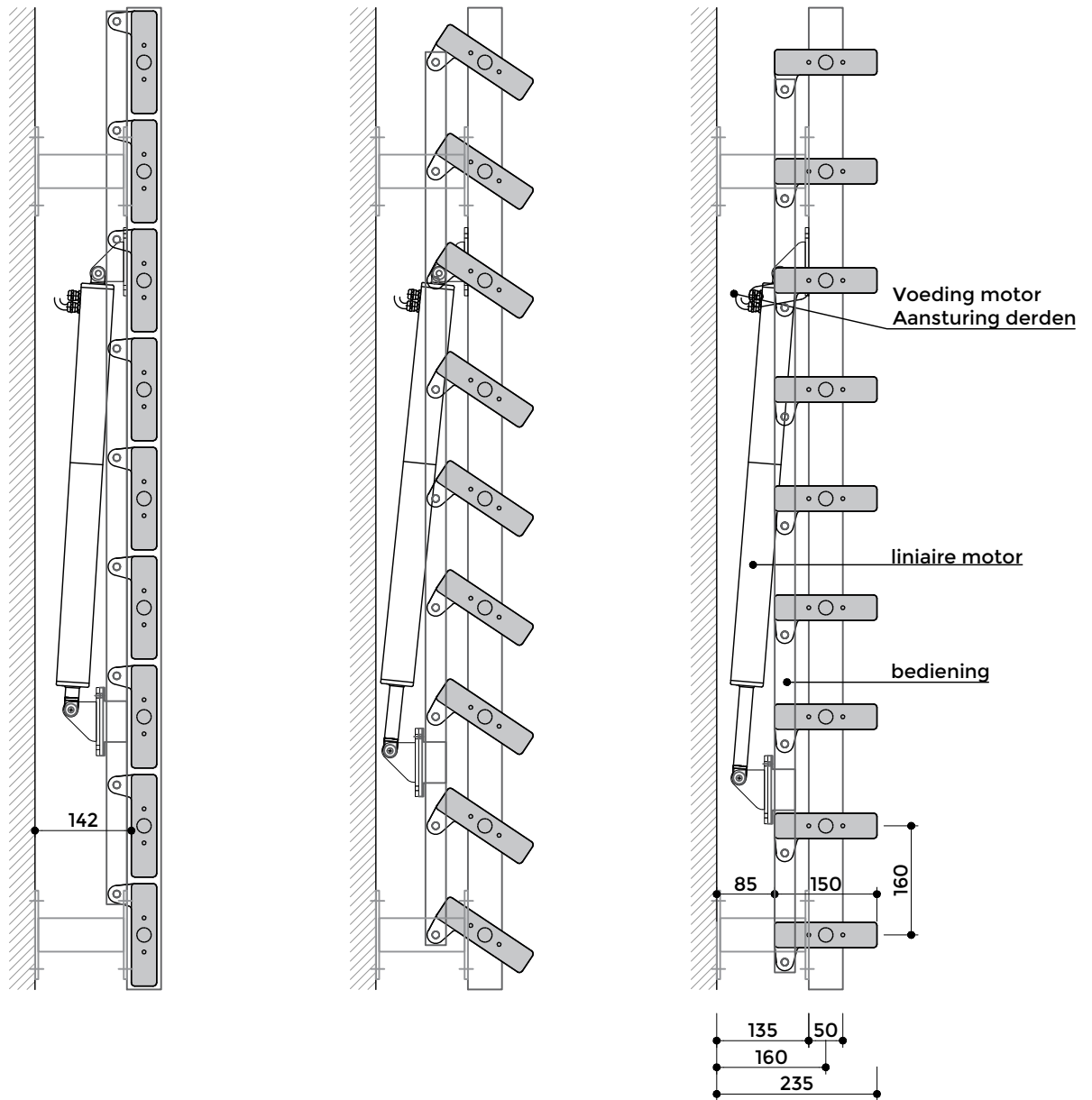
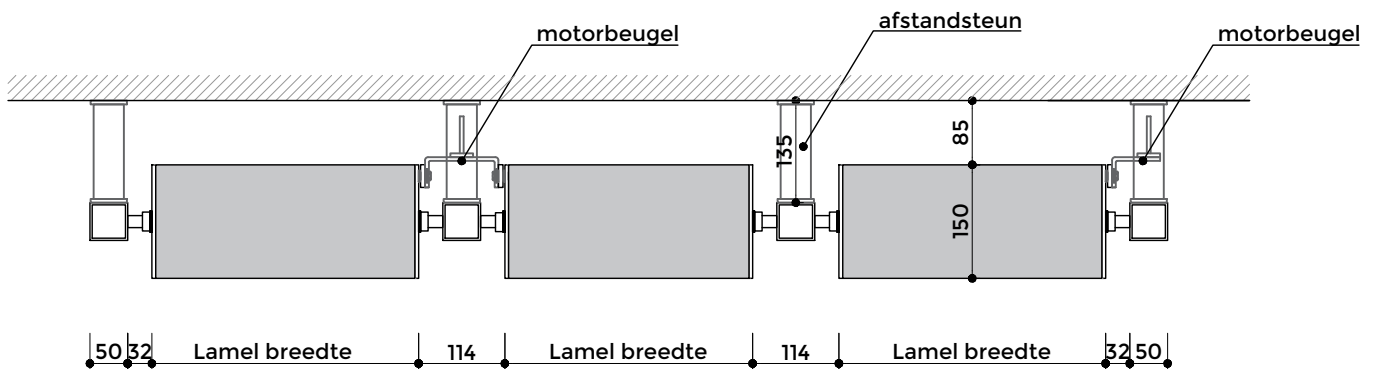
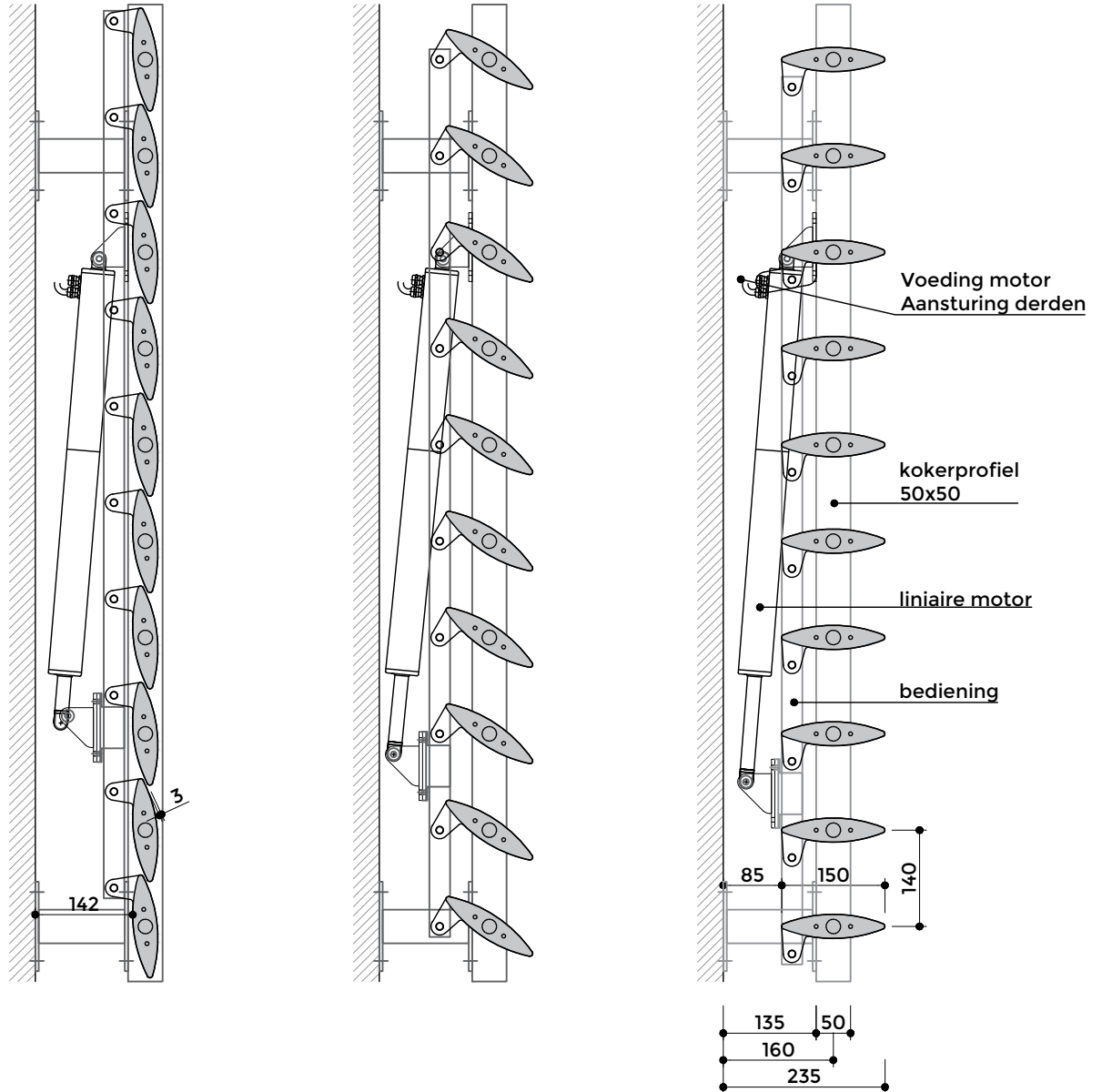

CAPITAL®

Aluminium - ellips 150 - gesloten - centraal draaiend

LENCO®

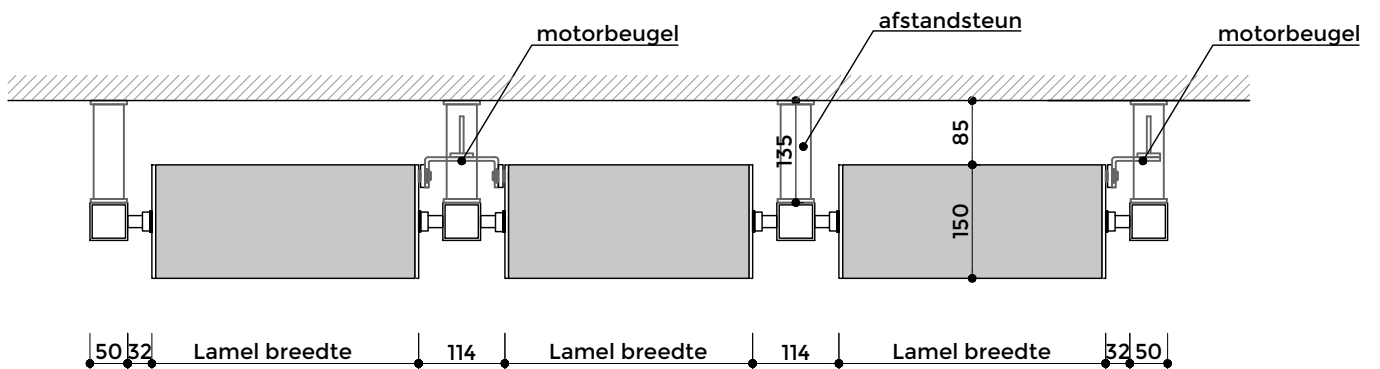
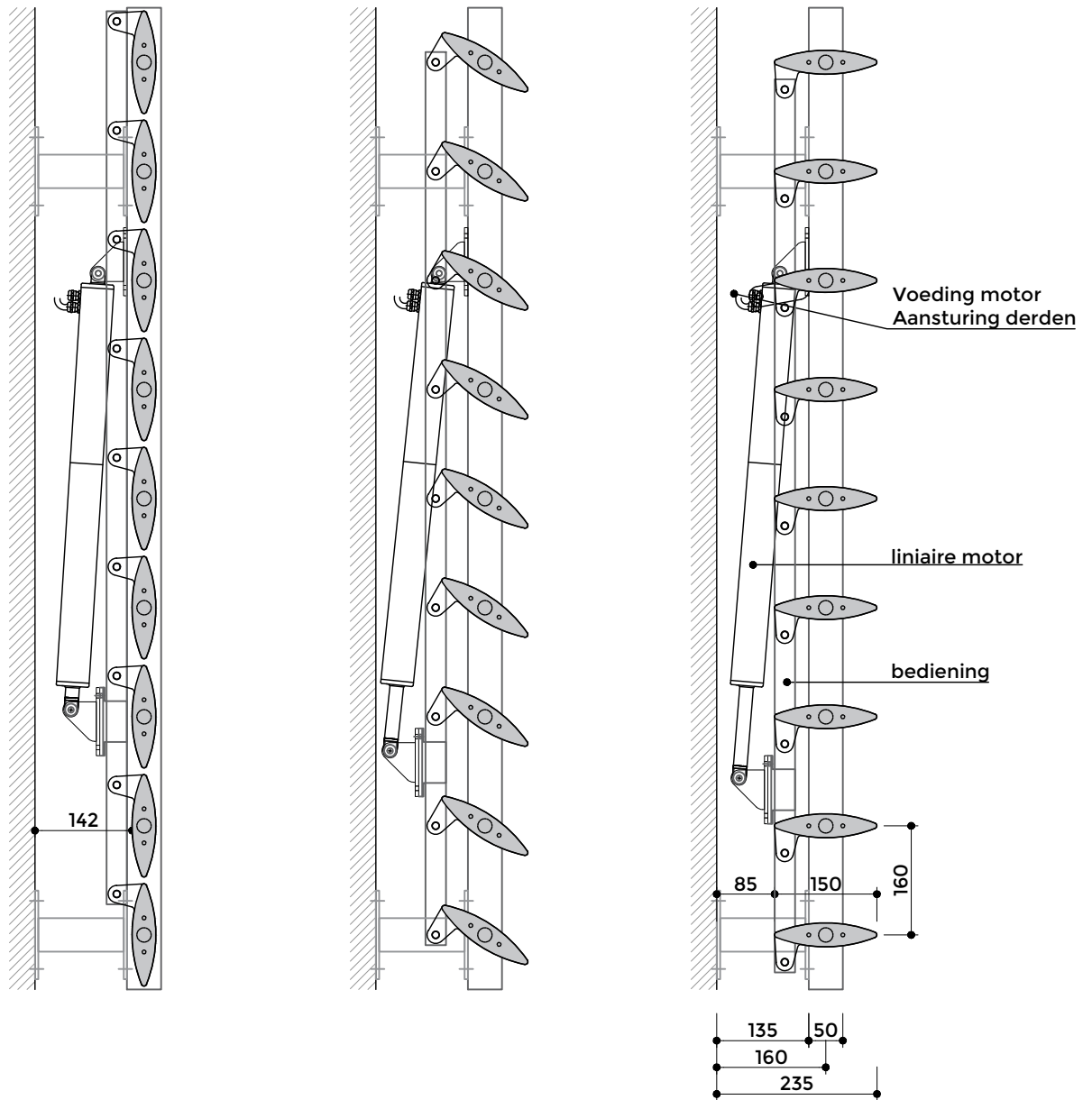

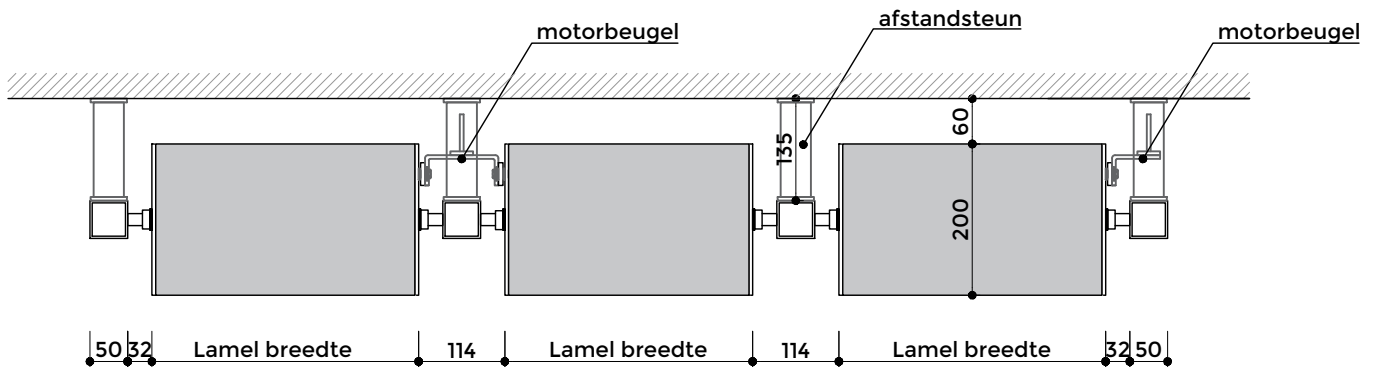
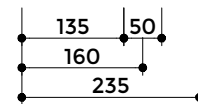
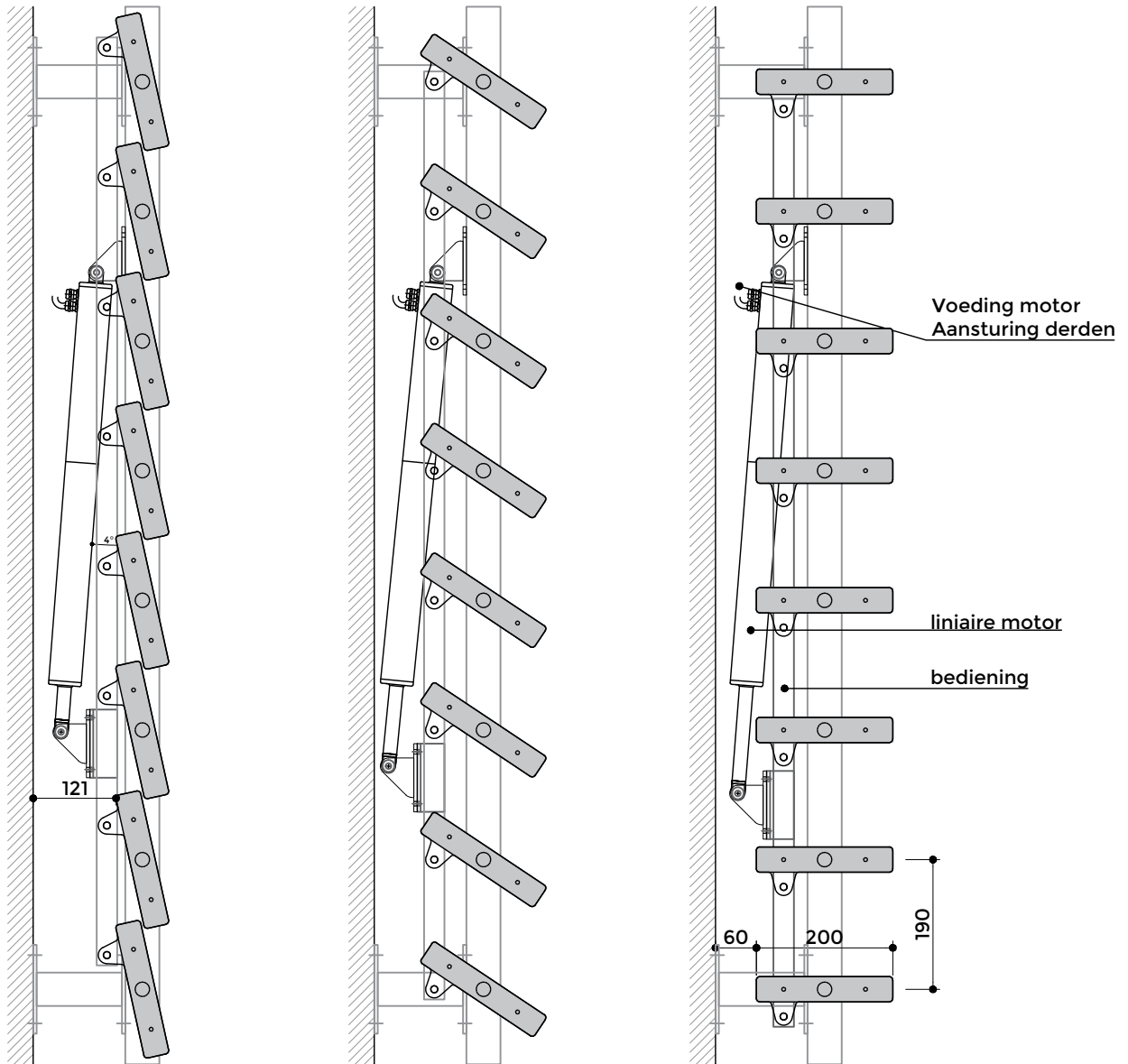

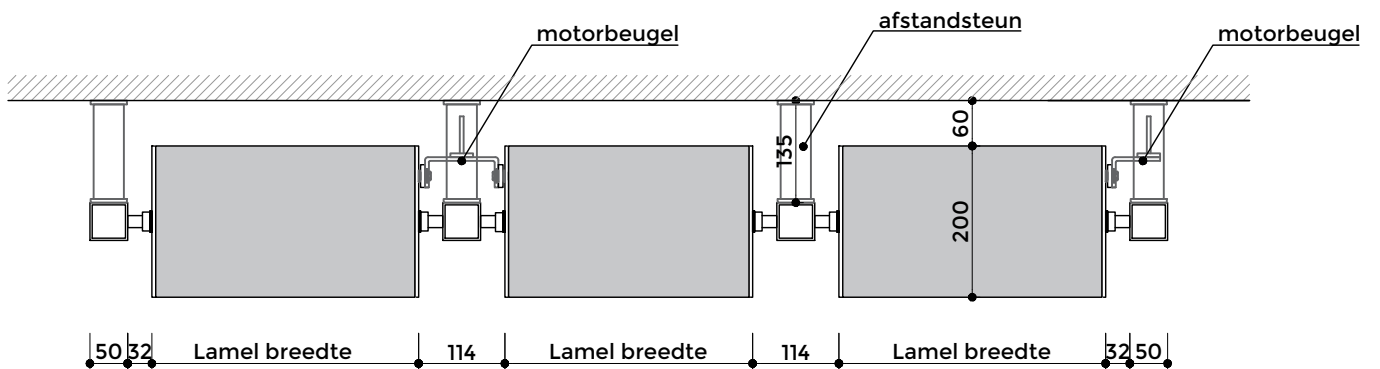
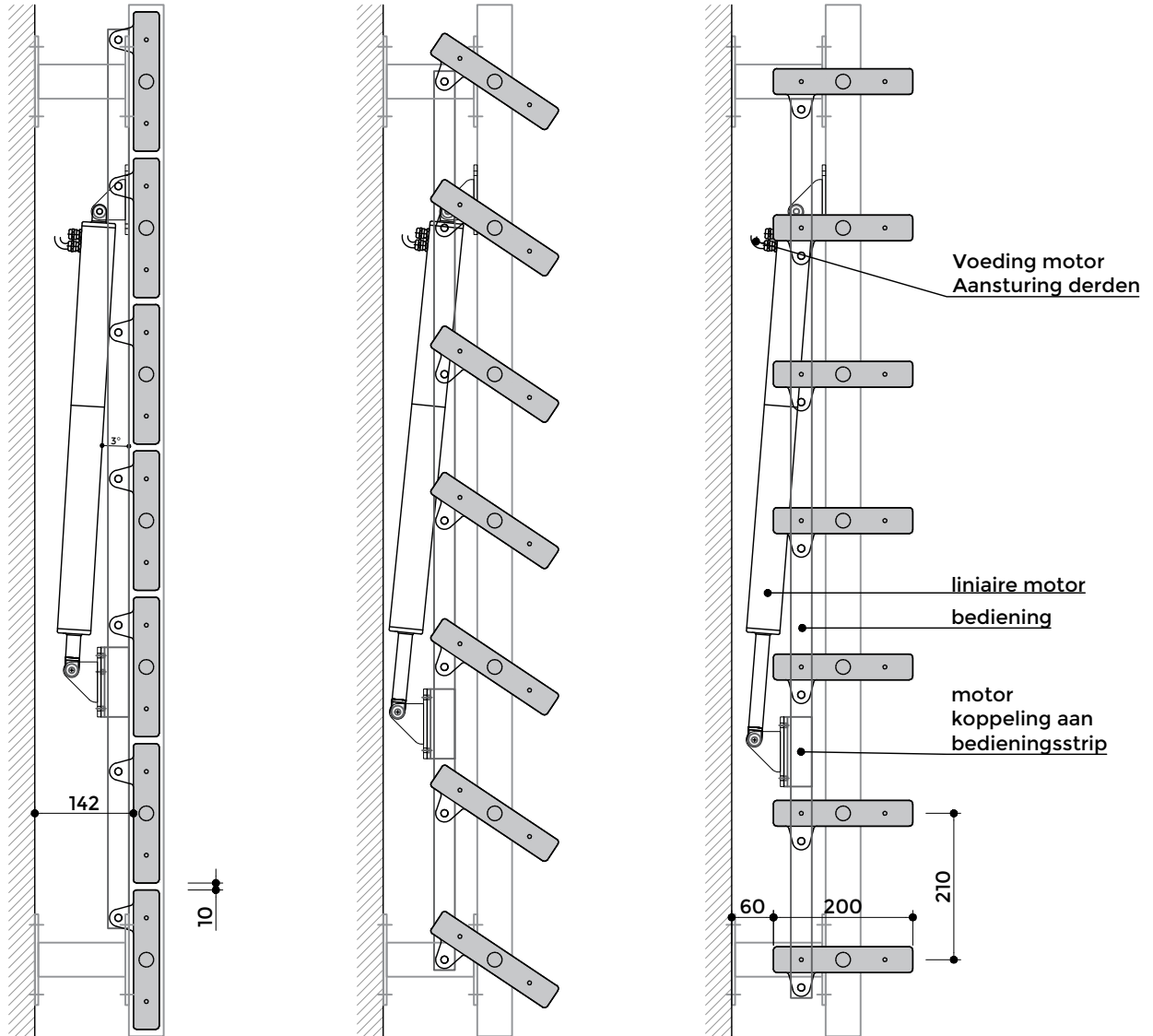

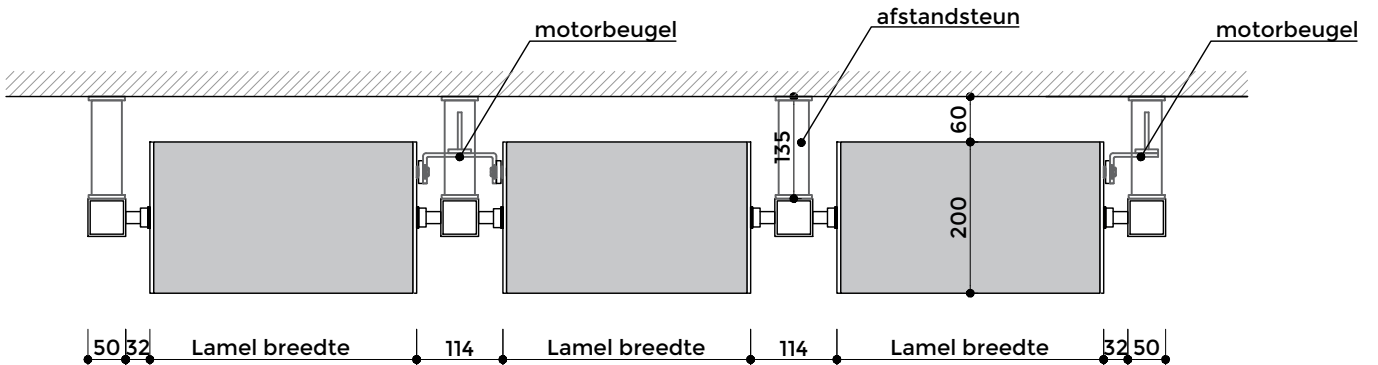
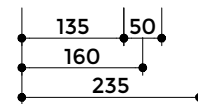
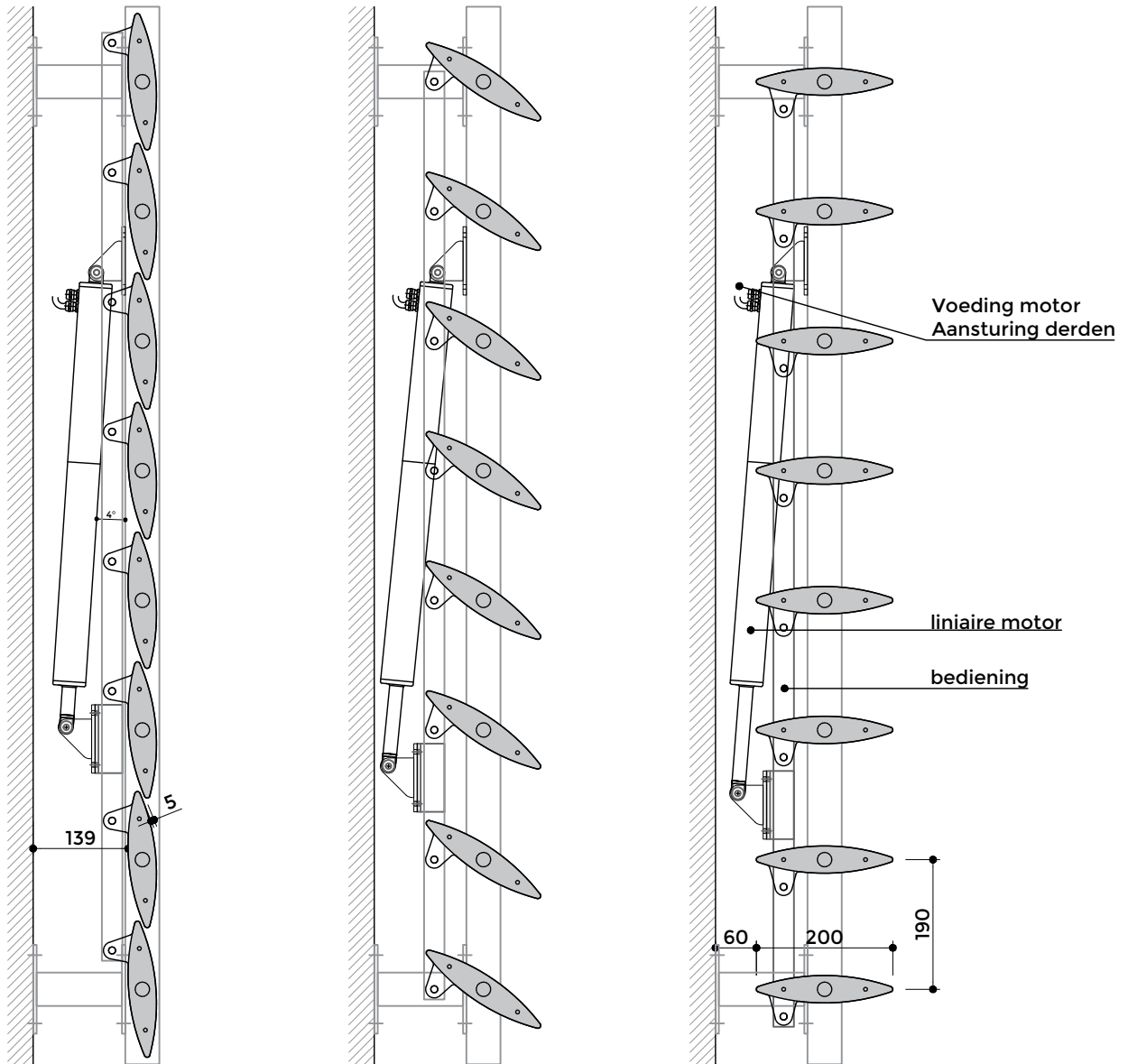

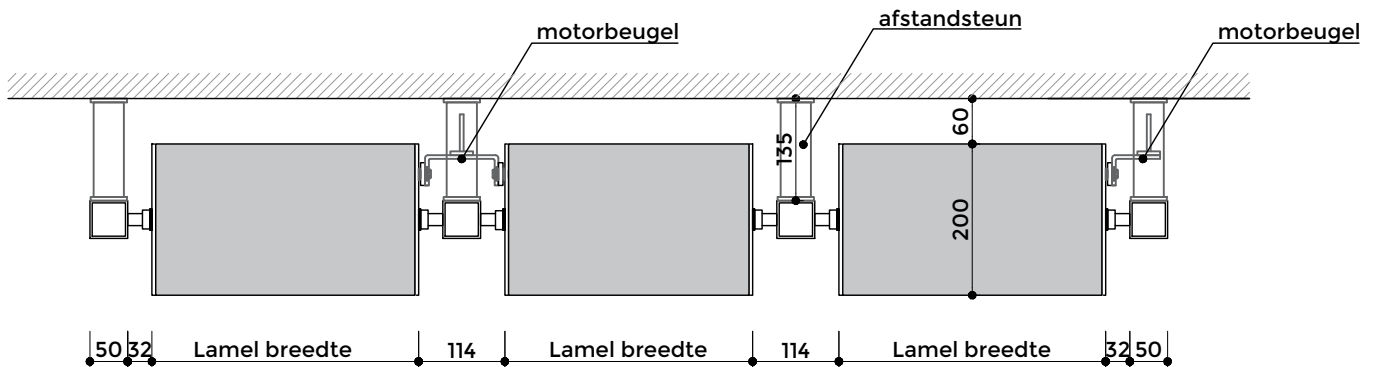
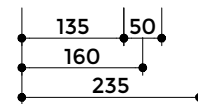
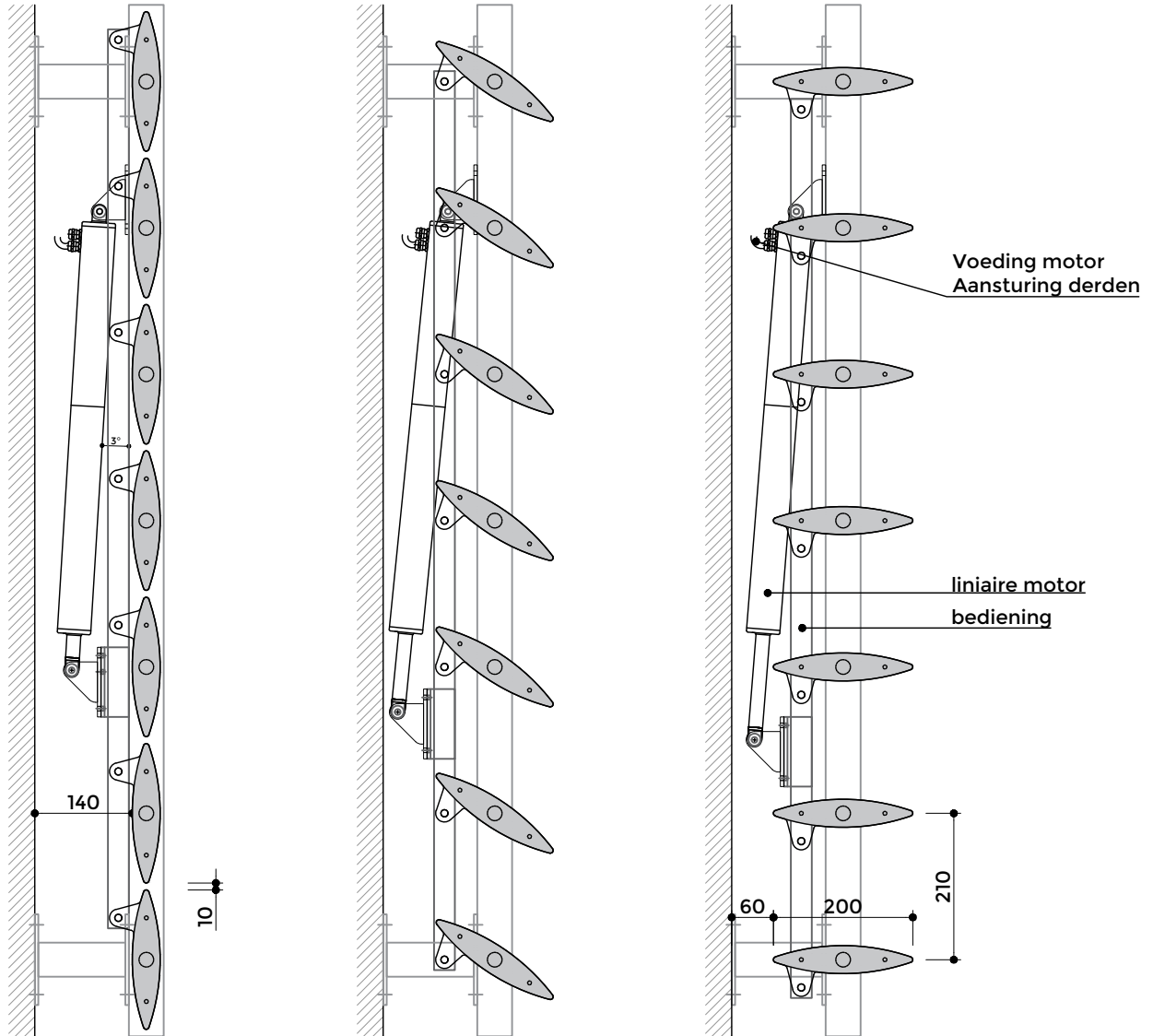

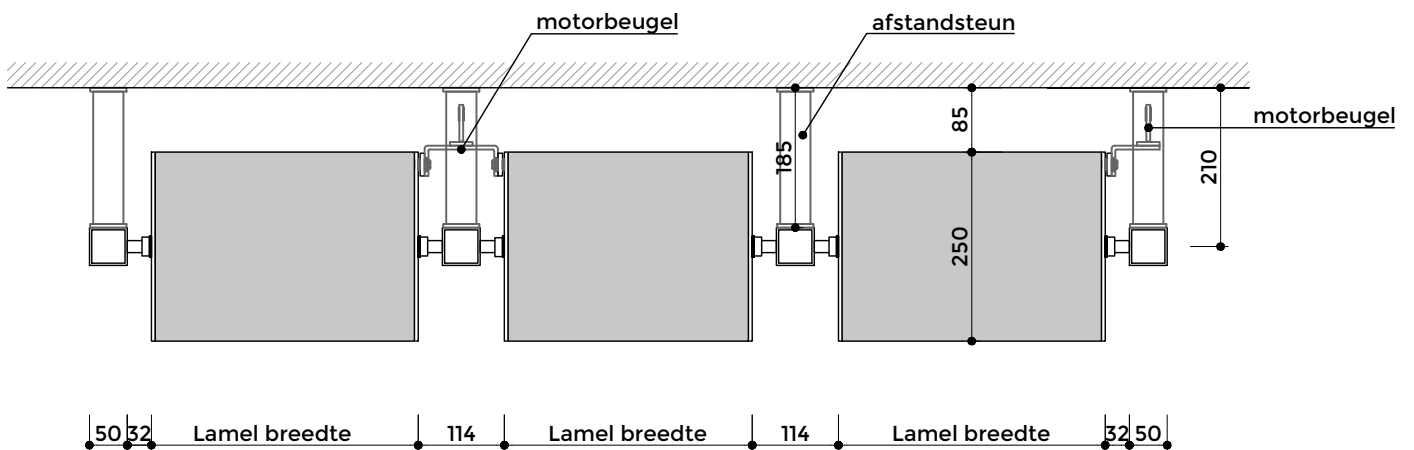
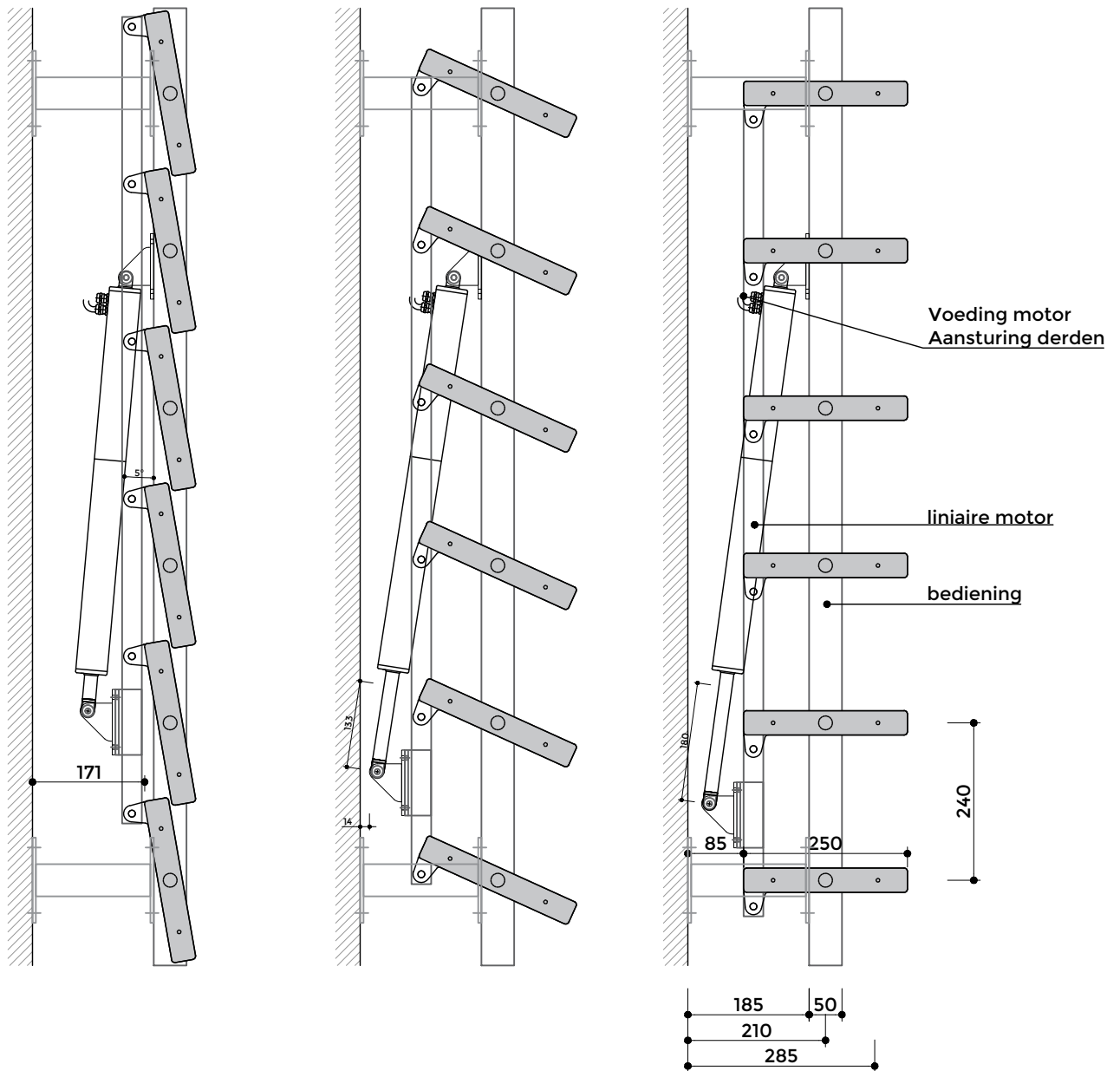

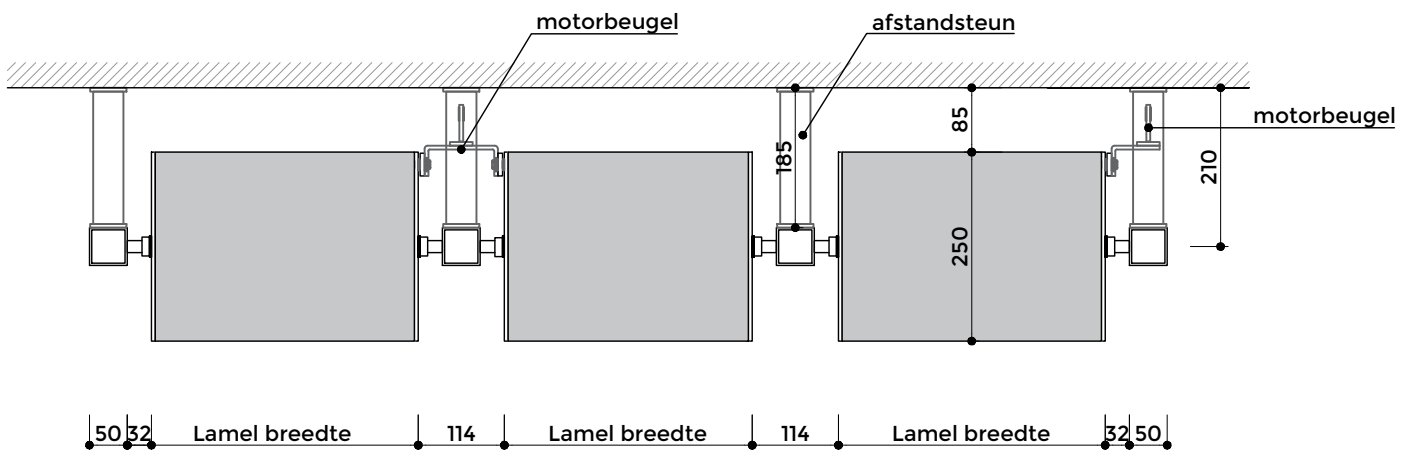
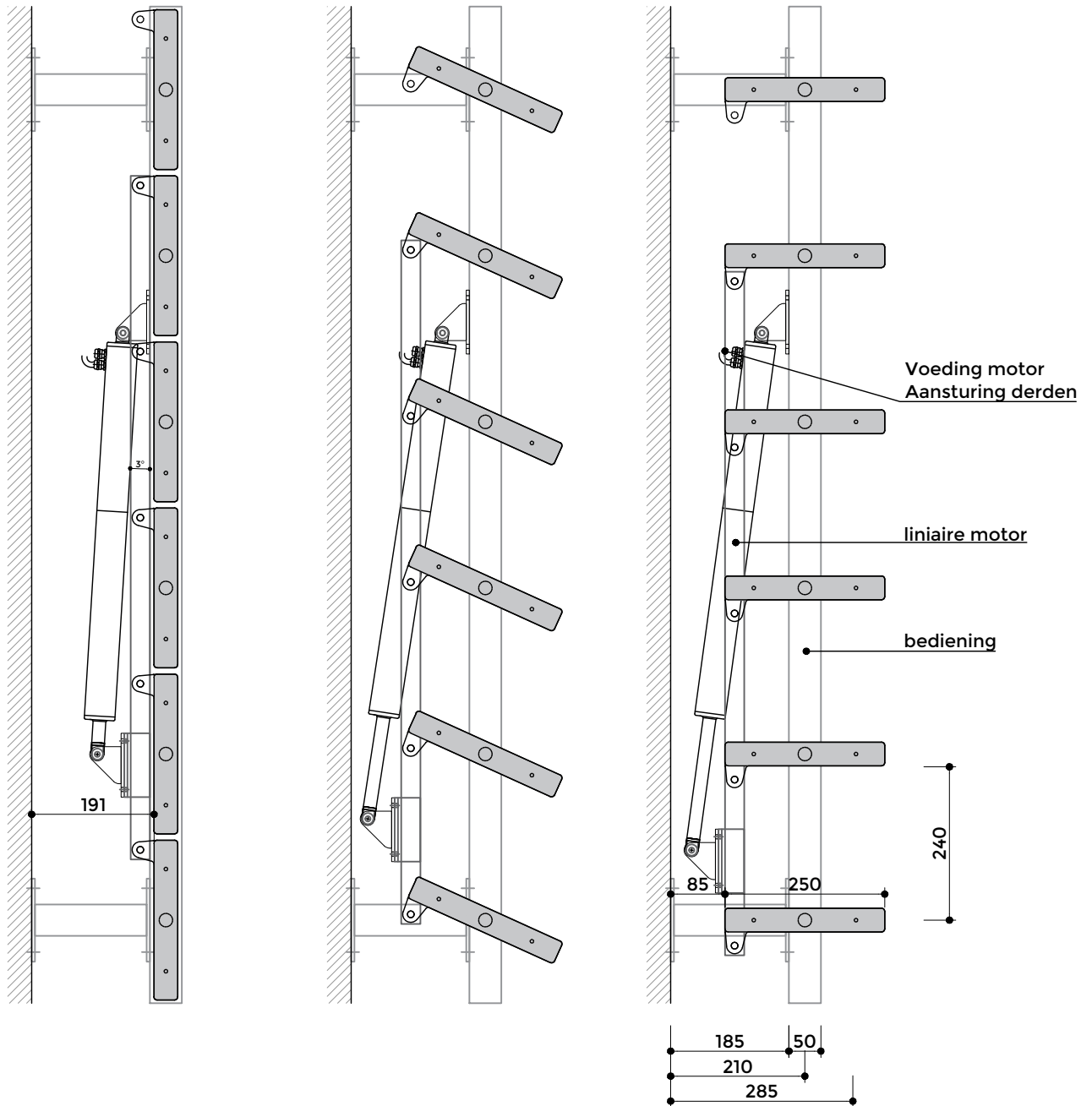

* Aanbrengen contrastekker excl. Lenco, na montage screen moet de stekker direct bereikbaar zijn.

Voor afmetingen en toepassing juiste onderlat zie afmetingen tabel.

Aluminium - ellips 250 - dakpan - centraal draaiend

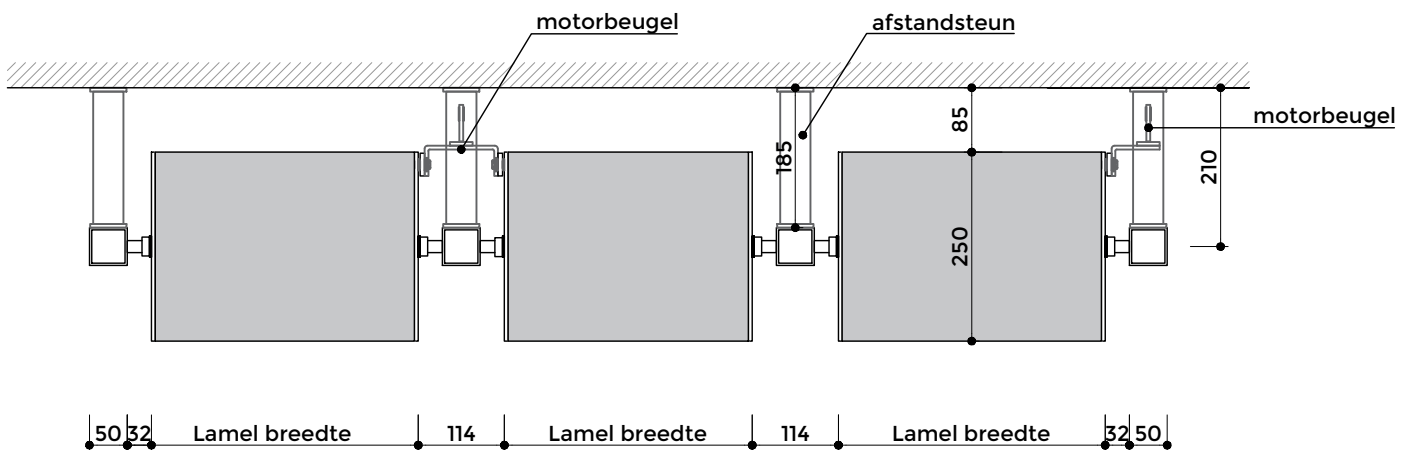
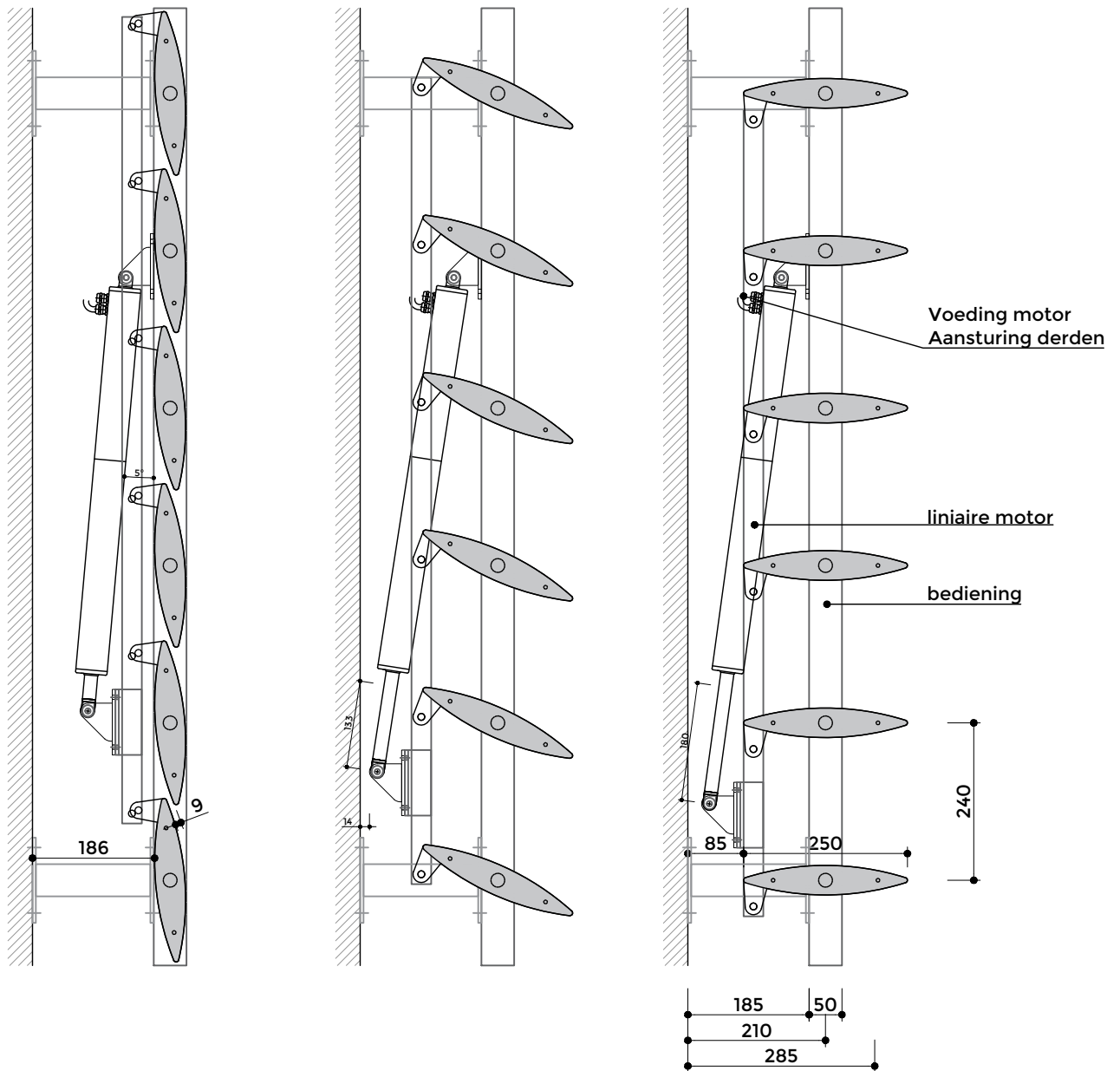

CAPITAL®

Aluminium - ellips 250 - gesloten - centraal draaiend

LENCO®

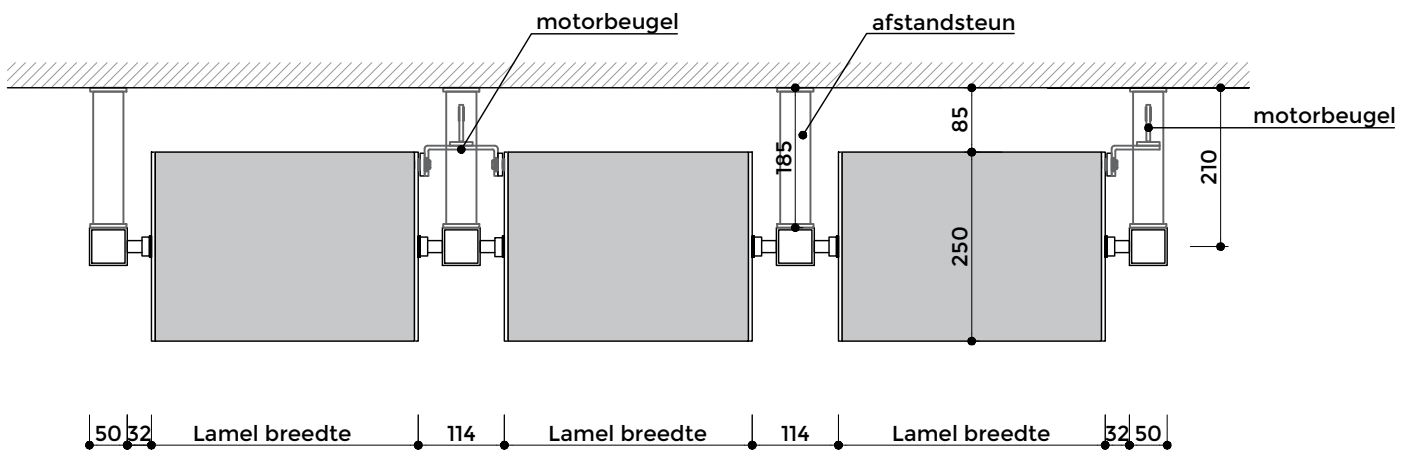
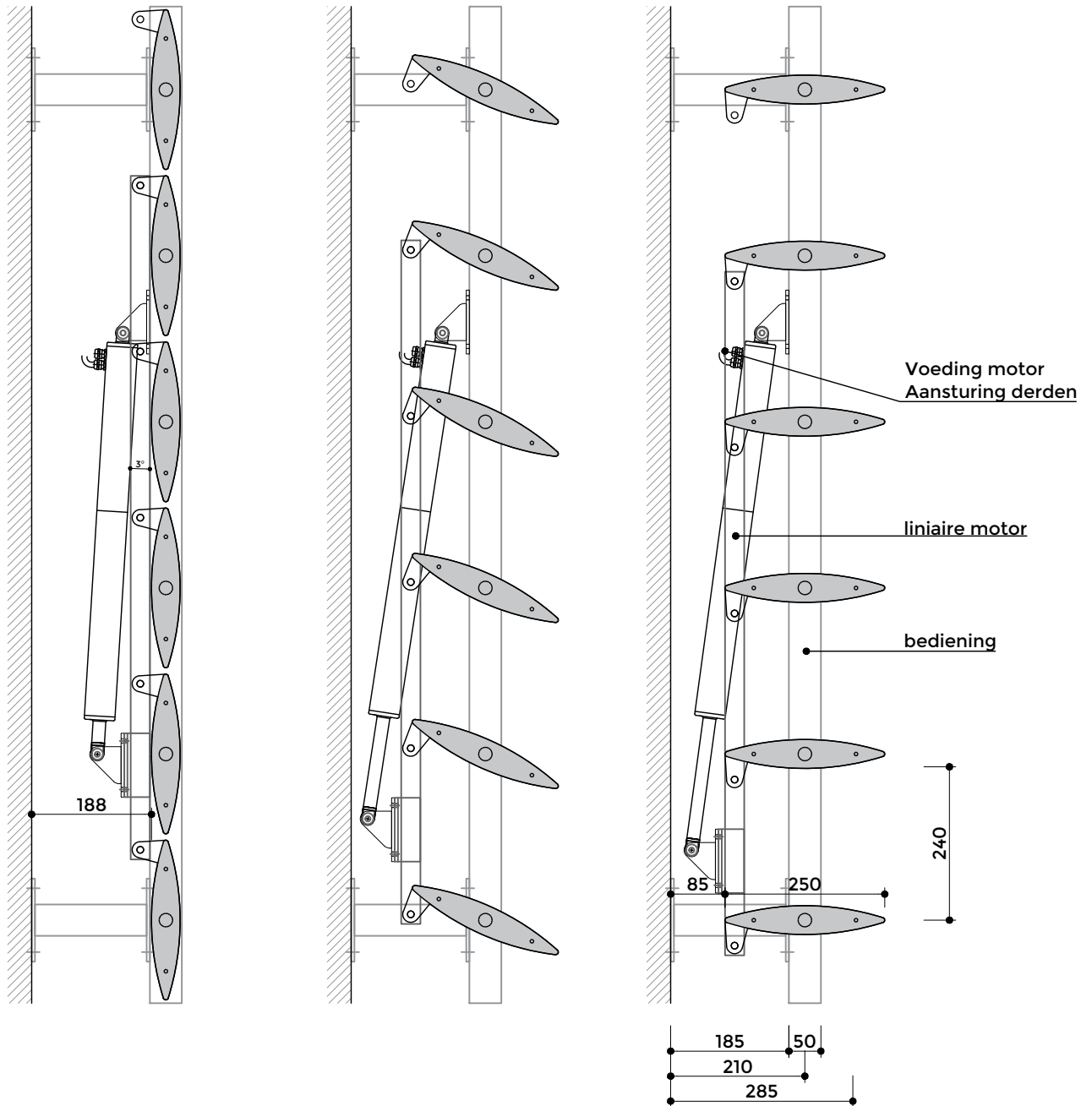

Aluminium - cubic 300 - dakpan - centraal draaiend

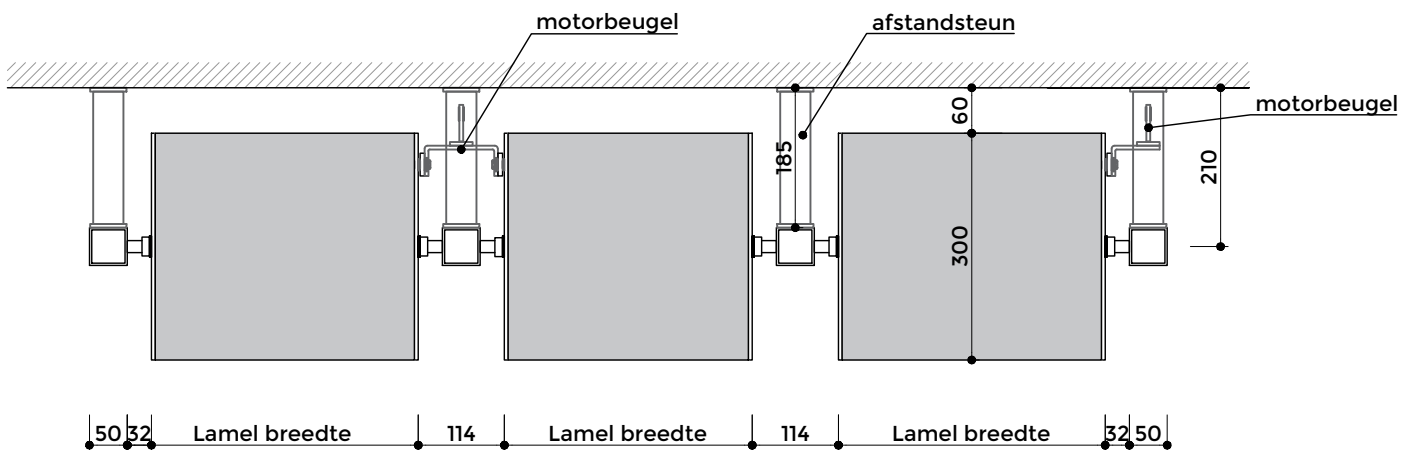
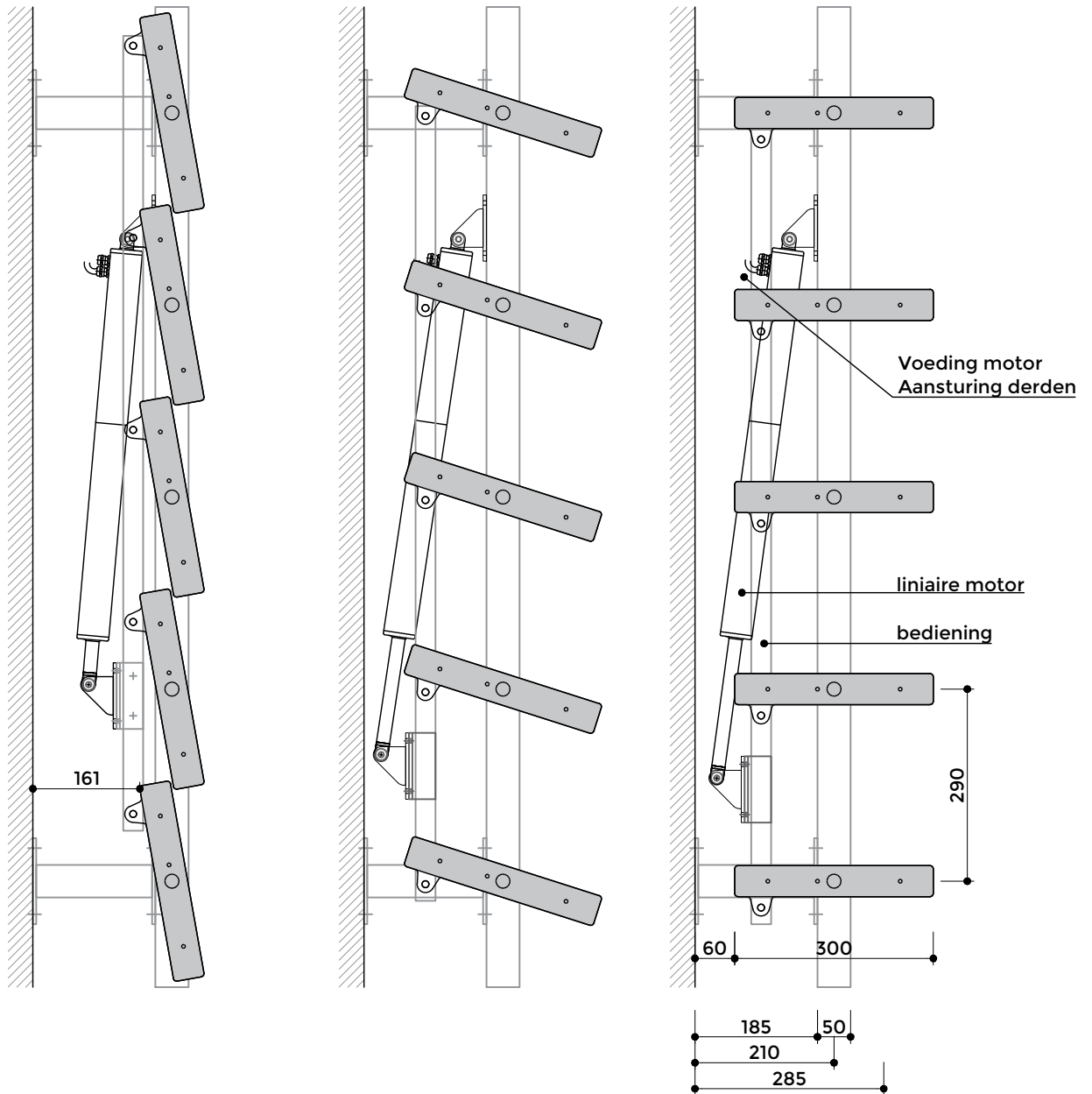

Aluminium - cubic 300 - gesloten - centraal draaiend

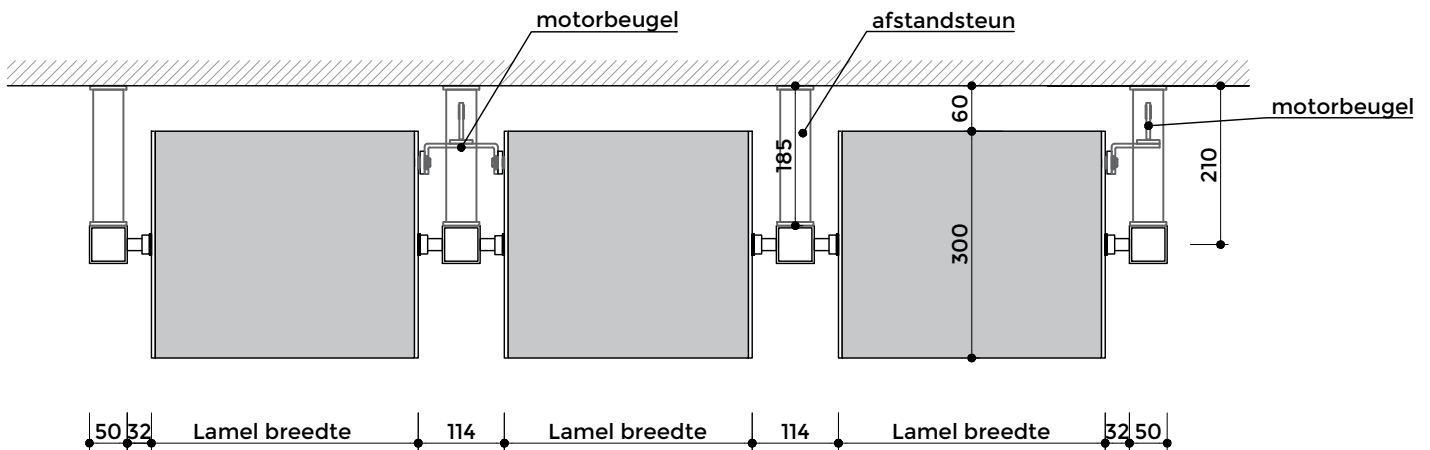
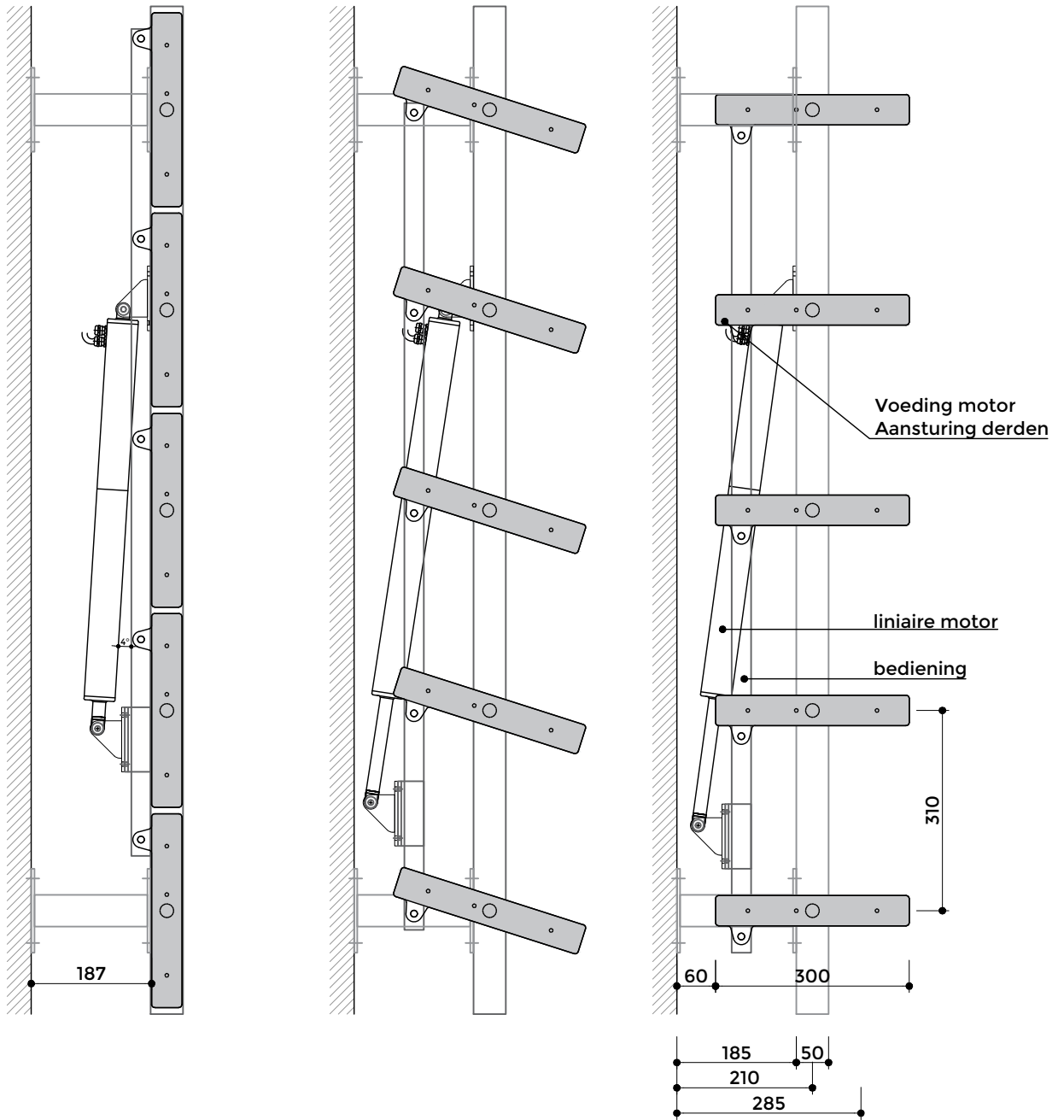

Aluminium - ellips 300 - dakpan - centraal draaiend

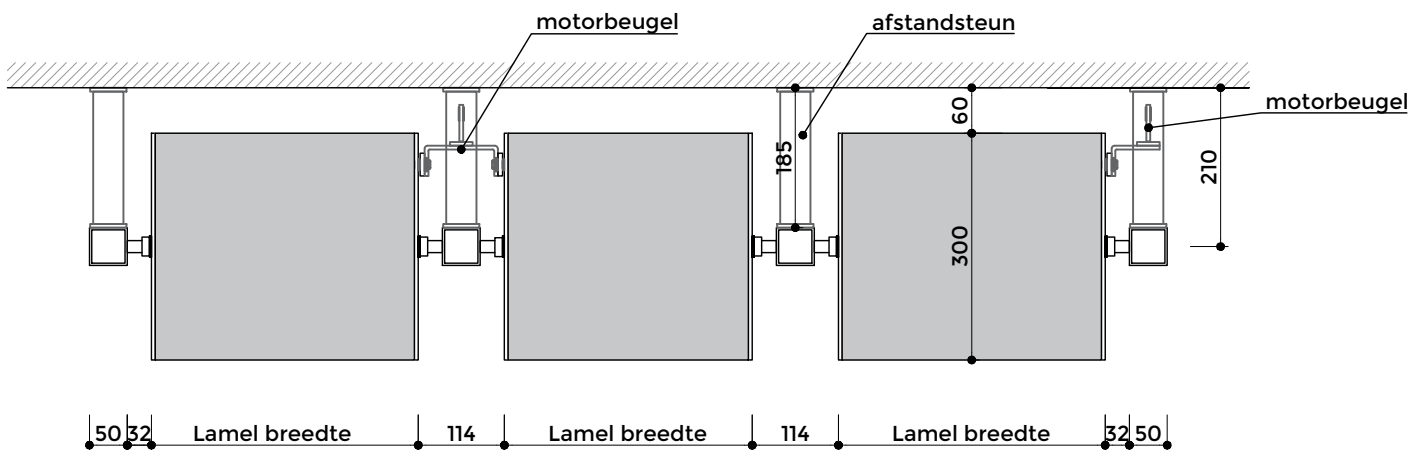
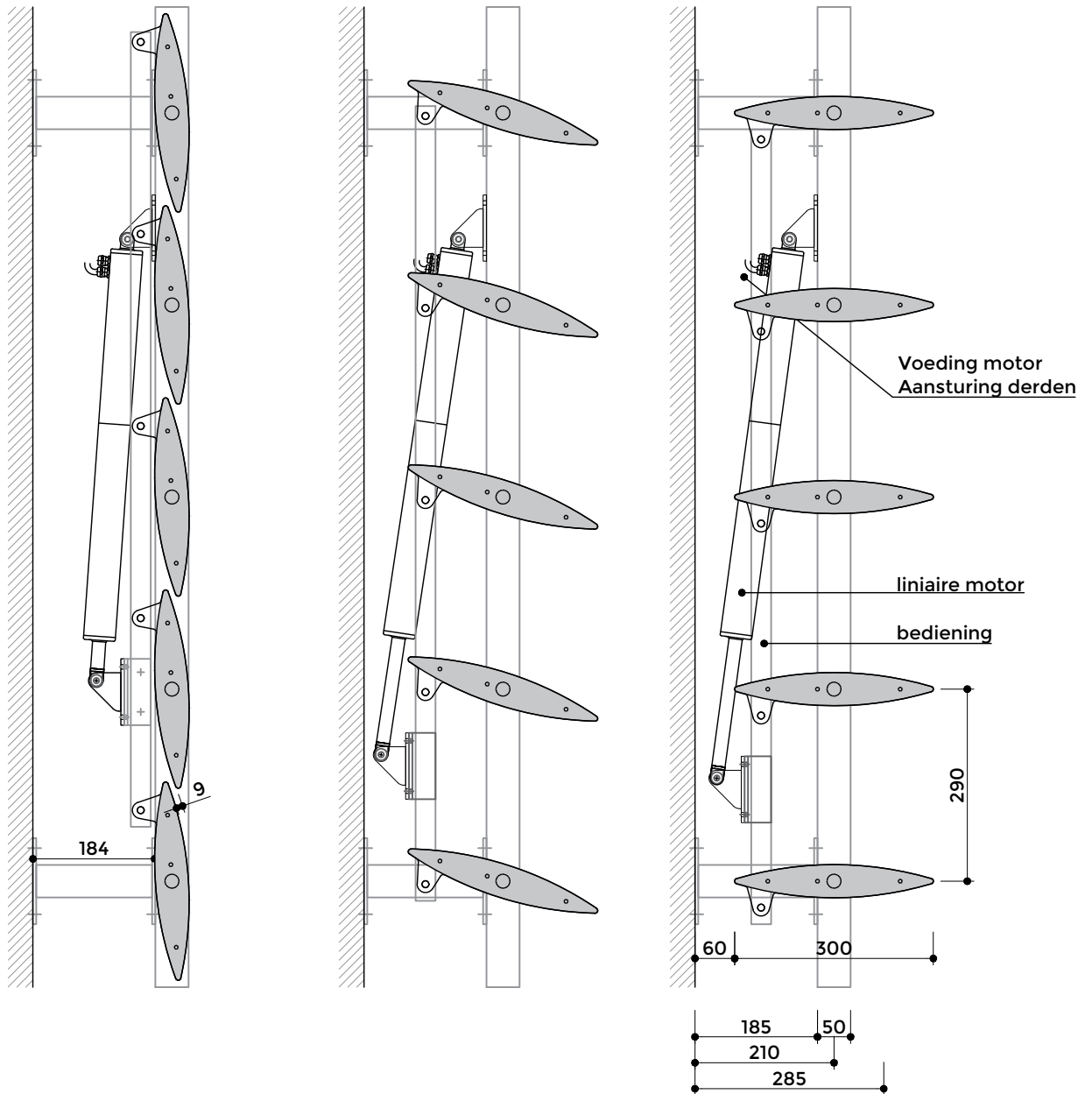

Aluminium - ellips 300 - gesloten - centraal draaiend

